

Operation Manual

Short Tine Scrub Grapple

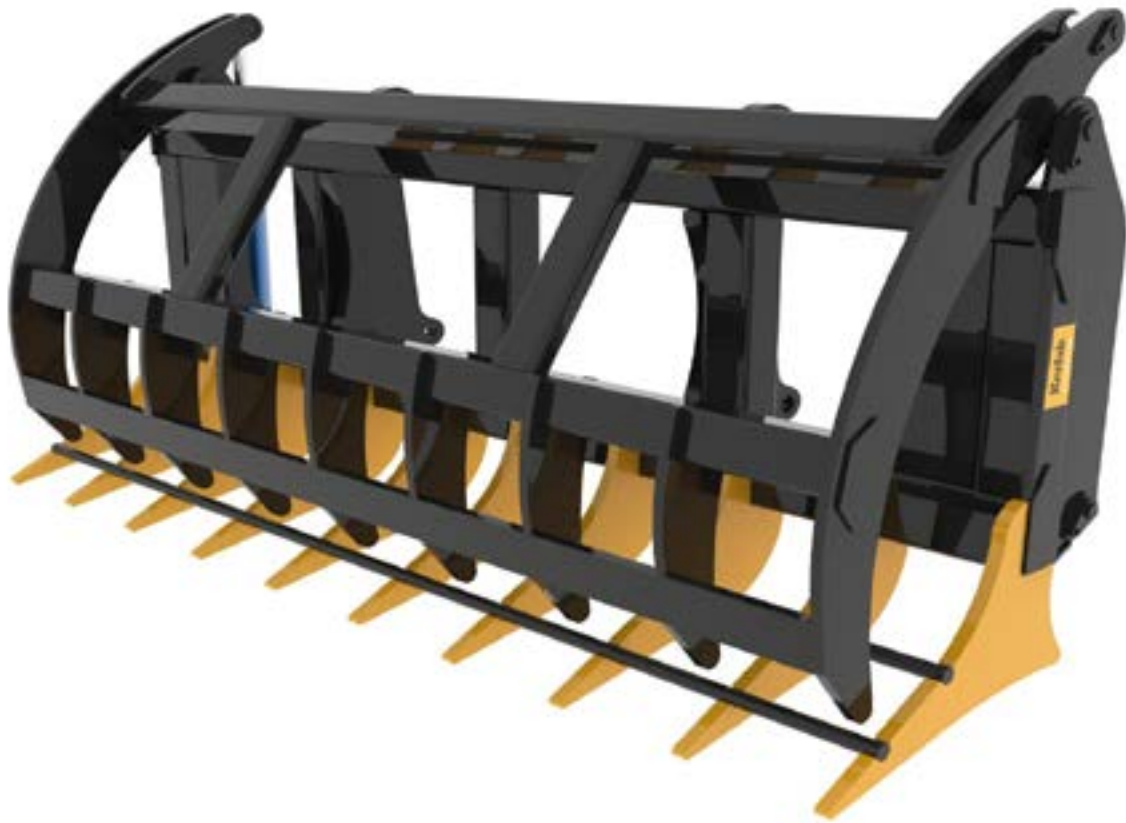

Dear valued customer, we kindly ask that you carefully review the operating manual for your product and complete the product registration process to ensure that you are eligible for warranty coverage. Thank you for taking the time to follow these important steps to protect your investment.



+ 1800 818 079

+ kerfab.com.au

+ sales@kerfab.com

Kerfab
ATTACH+GO

CONTENTS

INTRODUCTION	2
OWNER INFORMATION	2
GENERAL INFORMATION	3
PLANT ASSESSMENT	4
SORT TINE SCRUB GRAPPLE FEATURES	4
RISK ASSESSMENT AND CONTROL	5
WORKSITE SAFETY	6
MAINTENANCE	6
GREASE POINT DIAGRAM	7
MONTHLY INSPECTION	8
SPARE PARTS	9
OPERATING INSTRUCTIONS	10
HYDRAULIC SUPPLY INSTALLATION INSTRUCTIONS	14
PRODUCT REGISTRATION	15
KERFAB WARRANTY STATEMENT	16





INTRODUCTION

Kerfab is a specialist manufacturer of a comprehensive range of attachments covering a wide spectrum of market sectors. The Short Tine Scrub Grapple you have purchased is just one of a vast range of purpose-built products available in our range. Each attachment is engineered to relevant codes and standards along with input from experienced team which in turn provides you with an optimum item which will provide you with many years of service.

OWNER INFORMATION

Thank you for choosing to purchase a Short Tine Scrub Grapple from Kerfab. To ensure maximum performance, it is mandatory that you study this operation manual to ensure your equipment continues to operate to maximum performance. Proper operation and maintenance are essential to prevent injury or damage and to maximise attachment life.

Continuous improvement is at the forefront of the Kerfab culture meaning that changes in product design may not be reflected in this document. Great care has been taken in preparing this document with accuracy however Kerfab does not assume any liability for errors or omissions.

	Potentially Fatal Danger
	Risk of Serious Injury
	Risk of Material Damage and/or Minor Injury
	Maintenance operation or Information

GENERAL INFORMATION

This operation manual was written to provide the owner/ operator instructions on the safe operation and maintenance of the Short Tine Scrub Grapple Attachment.

PLEASE READ AND UNDERSTAND THE OPERATION AND MAINTENANCE OF YOUR SHORT TINE SCRUB GRAPPLE BEFORE OPERATING YOUR KERFAB ATTACHMENT.

Kerfab Short Tine Scrub Grapple are used on Telehandlers and Agricultural Tractors therefore this manual is a permanent part of your machine.

Attachment Inspection



All delivered products by Kerfab should be initially checked for any defects, damages or missing parts to ensure performance of attachment upon taking delivery of item.

Please notify Kerfab with a report of any problems within 10 business days.

Vital Point

Please keep this manual with the Machine once the attachment has been installed on the machine. The Operator should have a full understanding of full use of this attachment before use.

Attachment Features

The Short Tine Scrub Grapple is a robust attachment, capable of working across a range of industries and applications. The short, strong tines and grab are ideal for forestry, waste handling, site clearance, and demolition. The tines are designed to interlock to ensure a strong and secure grip on objects. Fitted with many features to increase strength and productivity, this attachment can be relied on. The pivot points are strengthened for increased lifespan and it also has a 33mm Bright Steel Cross Bar that runs across the Bottom Tines. Both the Beak and Bottom Tines are made from GR350 steel for increased durability. All hoses and rams are protected and kept out of harms way where necessary. This reduces the likelihood of damage and minimises downtime.

Plant Assessment

NB. This Plant Assessment ONLY applies to the attachment named below. It DOES NOT extend to other item(s) of plant that are used to operate this attachment

Plant Type:	Short Tine Scrub Grapple
--------------------	---------------------------------

Specifications:	Refer to the Identification Plate on the Short Tine Scrub Grapple for the specifications relevant to this attachment. The loads carried by the Short Tine Scrub Grapple should NEVER EXCEED THE LOAD LIMIT OF THE SHORT TINE SCRUB GRAPPLE OR THE LOAD LIMIT OF THE MOBILE PLANT it is attached to eg. or telehandler, in the full scope of each mobile plant’s operations.
------------------------	---







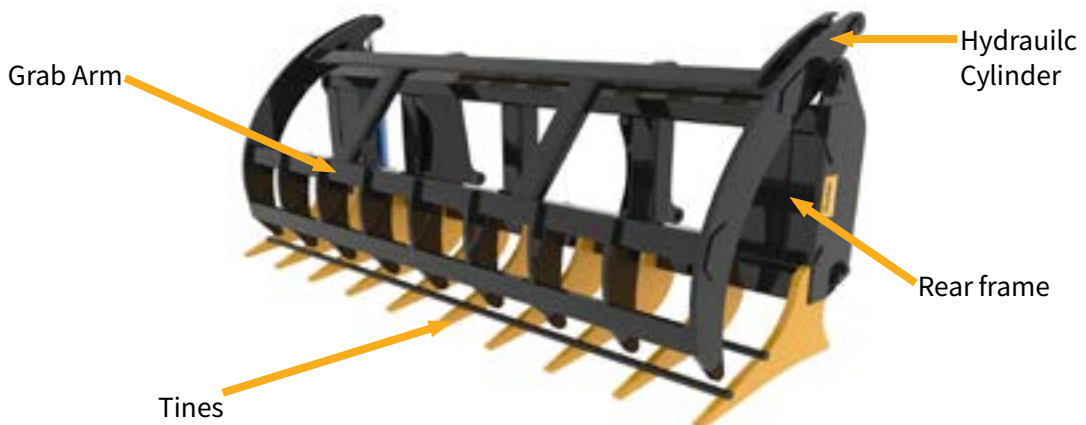







Description of Use:	The Short Tine Scrub Grapple is designed to save time and money in varying applications ranging from agriculture and forestry to demolition and waste management. The tines are designed to interlock to ensure a strong and secure grip on objects. NB: This attachment is to be only used for the purpose for which it is designed and intended.
----------------------------	--







Sort Tine Scrub Grapple Features



Risk Assessment and Control

Symbol	Risk	Control
 	<p>Body parts can be crushed between mobile plant mount and Short Tine Scrub Grapple attachment points when connecting Short Tine Scrub Grapple to the mobile plant mount.</p>	<p>Keep hands and body parts clear of area between Short Tine Scrub Grapple attachment point and mobile plant mount.</p>
 	<p>Fingers may be jammed in locking pin points as locking pins are engaged.</p>	<p>Keep fingers clear when engaging locking pins into locking pin points at rear of Short Tine Scrub Grapple.</p>
 	<p>Hydraulic fluid under pressure may cause injury if released while under pressure.</p>	<p>Ensure all hoses and connectors are in good working condition. Ensure all connections are secured and correctly sealed before using hydraulic controls.</p>
 	<p>Body parts can be crushed if Short Tine Scrub Grapple unexpectedly releases from mobile plant mount.</p>	<p>Ensure Short Tine Scrub Grapple is securely attached prior to use including fully engaging lower pins. Regularly check that hitch points on Short Tine Scrub Grapple and also mobile plant mount parts are in good condition.</p>
 	<p>Moving grab tines can trap and crush body parts.</p>	<p>Keep hands and body parts clear of area between Short Tine Scrub Grapple tine and base tines or load. Keep hands clear of area around upper ram pivot point and grab tine pivot points when opening or closing grab tines.</p>
 	<p>Body parts can be crushed by unexpected release or movement of load.</p>	<p>Ensure larger material is tightly secured in Short Tine Scrub Grapple prior to lifting. Regularly check Short Tine Scrub Grapple for damaged or bent/distorted parts and damaged welds.</p>
 	<p>Body parts can be crushed by unexpected tipping of Short Tine Scrub Grapple.</p>	<p>Ensure Short Tine Scrub Grapple is stable when released from mobile plant mount. Use stable chocks to support rear frame if necessary.</p>

<h2 style="margin: 0;">Worksite Saftey</h2> 	
	<ul style="list-style-type: none"> All people involved in the operation are to wear appropriate personal protective equipment which may include eye protection, hearing protection, gloves, protective footwear, and high visibility clothing/vests.
	<ul style="list-style-type: none"> Short Tine Scrub Grapple should ONLY be operated by a trained and experienced operator or an operator under direct supervision.
	<ul style="list-style-type: none"> Person/s should NOT enter the work area or sweep the area of attachment and load unless under the direction of the operator.
	<ul style="list-style-type: none"> NEVER walk under the Short Tine Scrub Grapple or load.
	<ul style="list-style-type: none"> NEVER elevate Short Tine Scrub Grapple or load above or in the direct proximity to people.
	<ul style="list-style-type: none"> Ensure all persons are clear of Short Tine Scrub Grapple when it is being hitched or released.
	<ul style="list-style-type: none"> Ensure Grapple is as low as possible when traveling.

<h2 style="margin: 0;">Maintenance</h2>		
	Check hydraulic hoses, connections, and ram seals for damage and/or leaks.	
	Check the Short Tine Scrub Grapple arms/ram pivot point and Short Tine Scrub Grapple swivel point for damage and wear.	
	Check all tines, grab arms, and rear frame for damage or bends/distortions.	
	Check all welds for damage or cracks.	
<p>DO NOT USE THE SHORT TINE SCRUB GRAPPLE IF WEAR OR DAMAGE MAKES THE USE OF THE SHORT TINE SCRUB GRAPPLE HAZARDOUS</p>		

GREASE POINT DIAGRAM

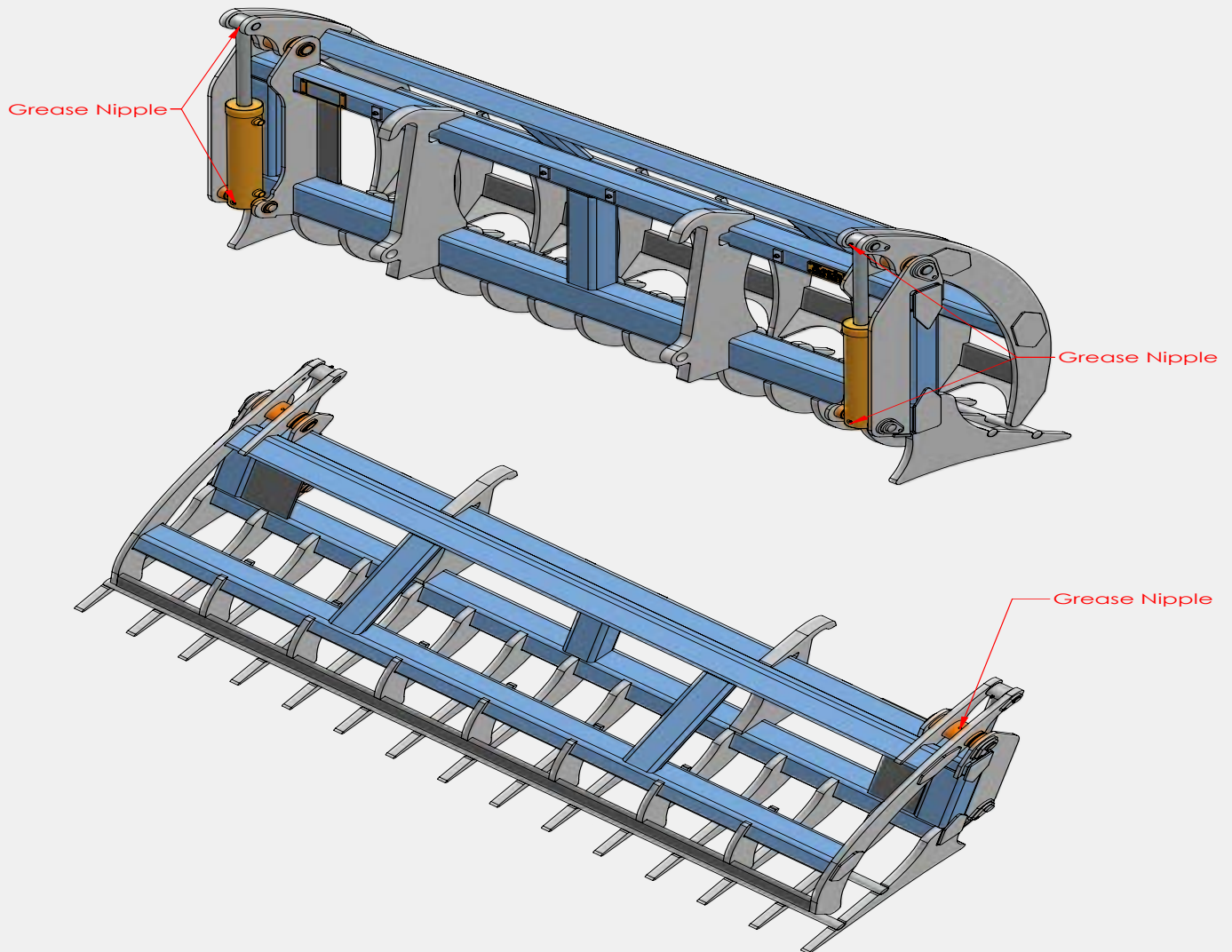

- Ensure the unit is greased via grease nipples as shown.
- Ensure that the attachment is greased every 12Hr of use



MONTHLY INSPECTION

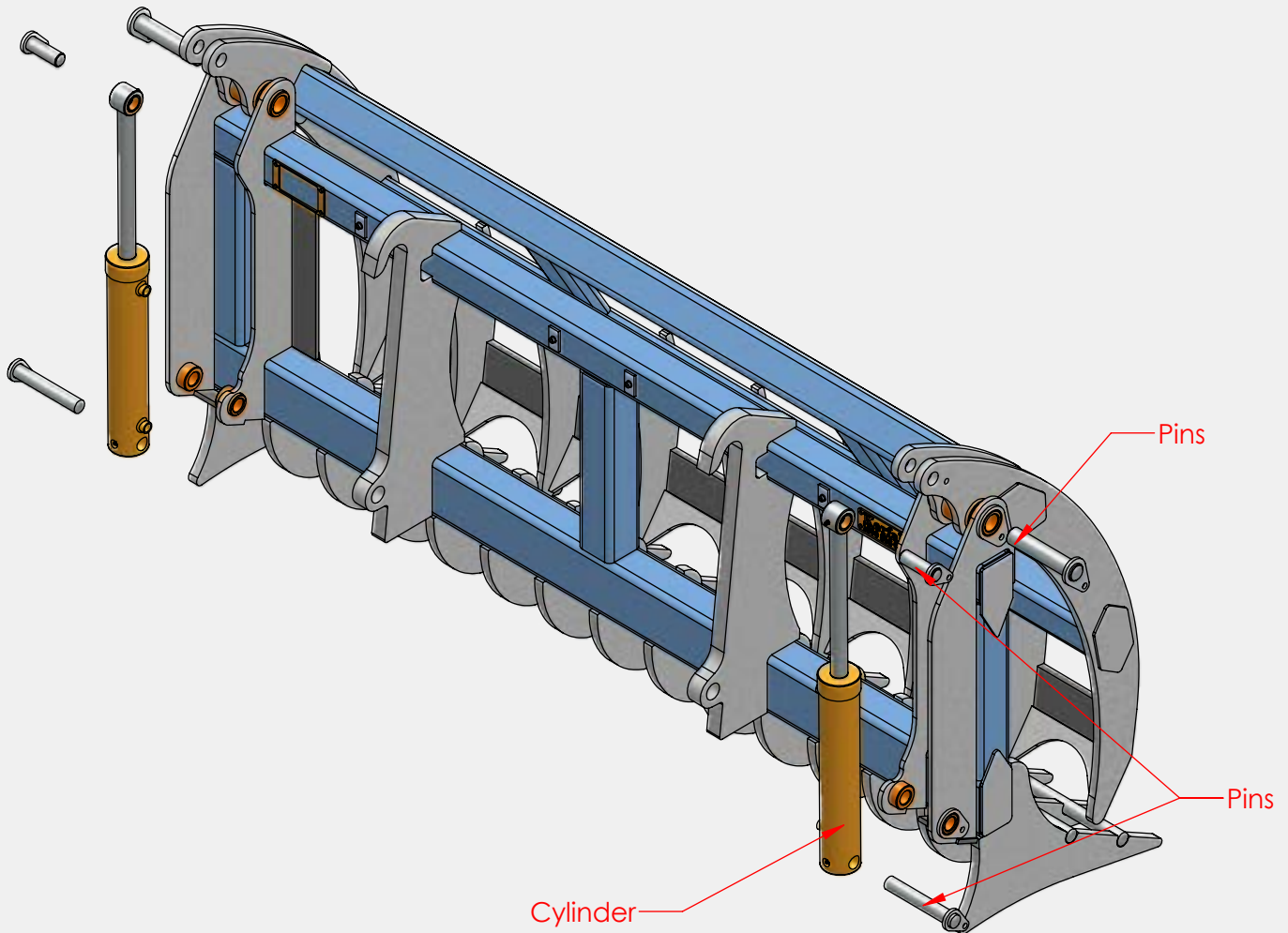

1. Inspect cylinder and hoses for wear and are free from hydraulic oil leaks.
2. Inspect cylinder pins for wear.
3. Inspect frame runners for wear or distortion
4. Check all welds for damage or cracks

SPARE PARTS

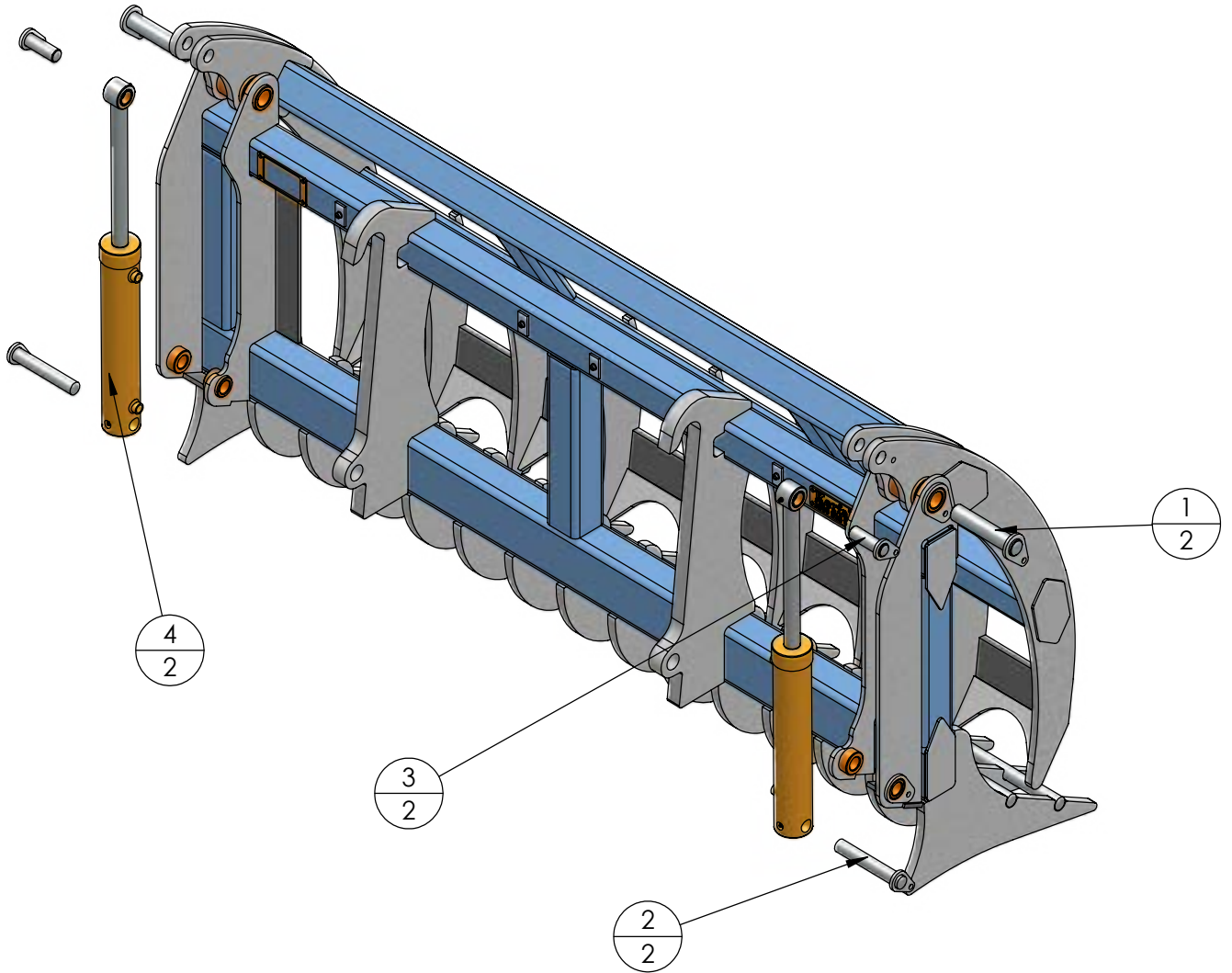

NO.	DESCRIPTION	QTY
1	GRAPPLE PIN ASSEMBLY	2
2	LOWER PIN	2
3	UPPER PIN	2
4	CYLINDER	2

OPERATING INSTRUCTIONS

ENGAGING IMPLEMENT STEPS

STEP 1

Approach Short Tine Scrub Grapple with top pick-up bar in sight and aligned with quick hitch hooks.

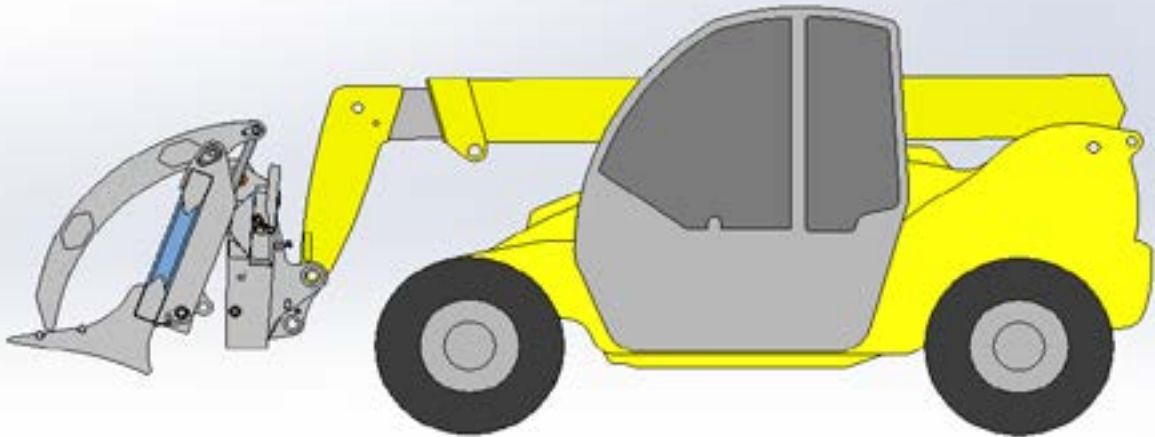

STEP 2

Engage top bar with hook by raising loader arms. Roll Short Tine Scrub Grapple back to ensure hook stopper is resting against the coupler. Engage quick coupler locking pins.

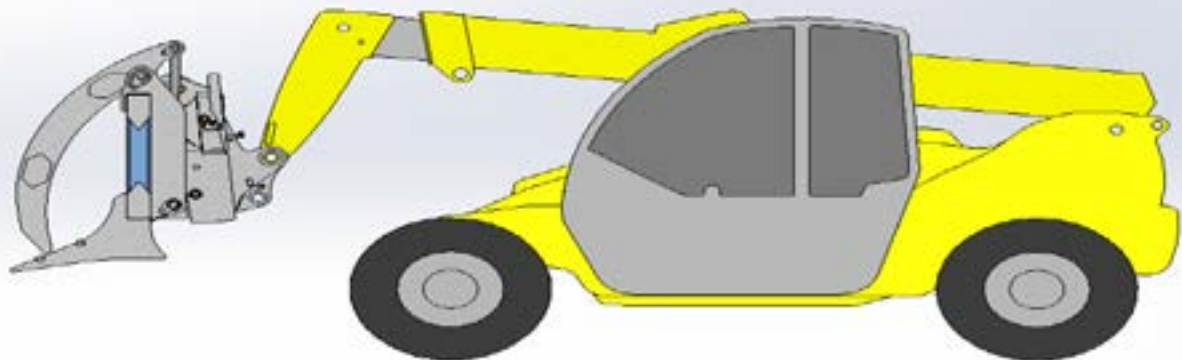

STEP 3

Check that locking pins are engaged by view indicators. Note: Models with no indicators will require a physical check by the operator

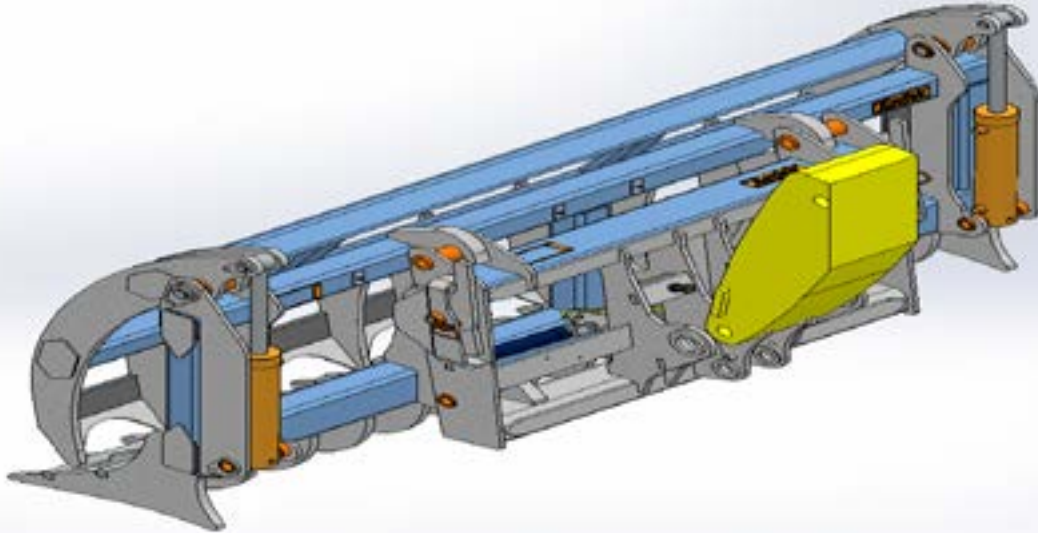
**DISENGAGING IMPLEMENT STEPS****STEP 1**

Slightly roll back implement to ensure hook bump stops are resting against the quick coupler. Disengage locking pins.

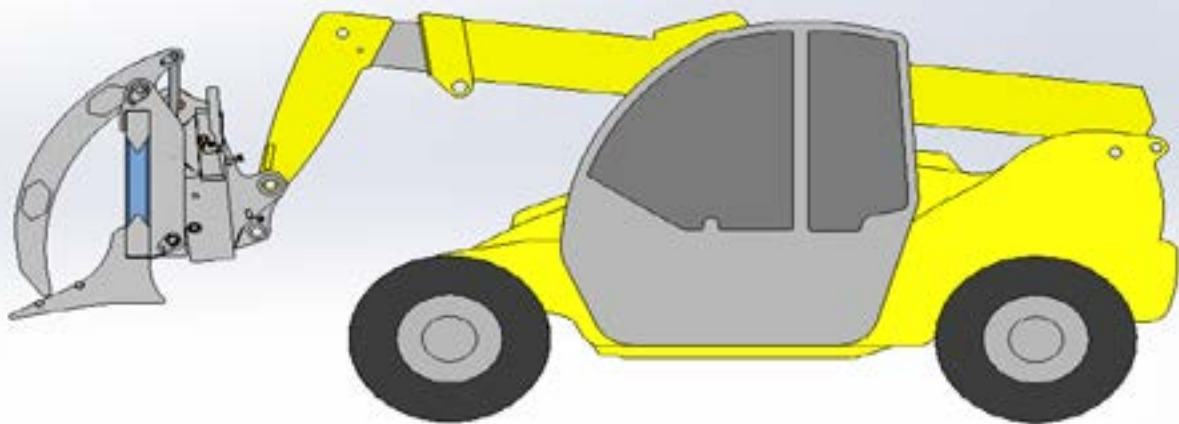

STEP 2

Check that locking pins are disengaged. Note: Models without indicators may need a physical check by the operator.

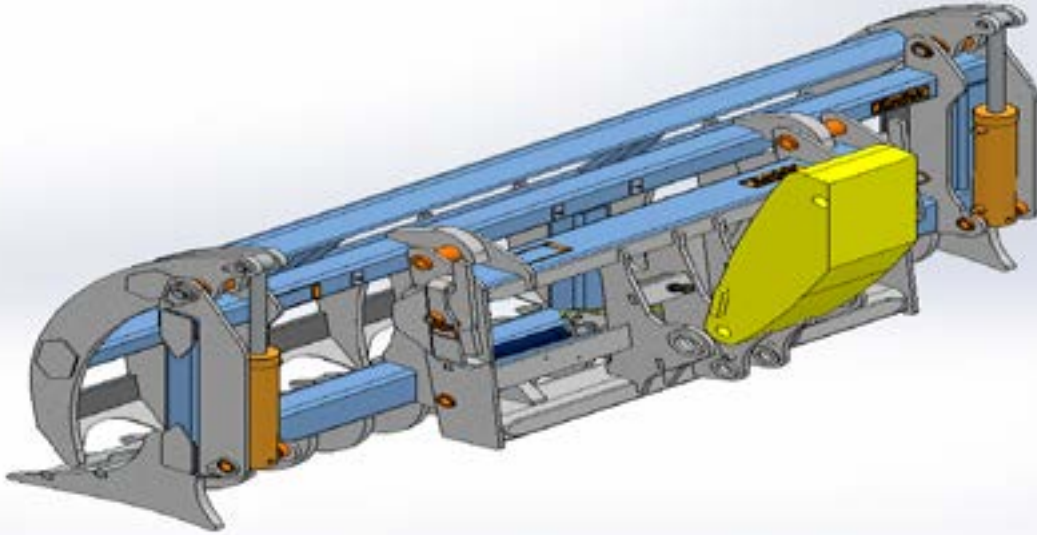
**STEP 3**

Slightly roll coupler forward to rest front of Short Tine Scrub Grapple on the ground as shown.

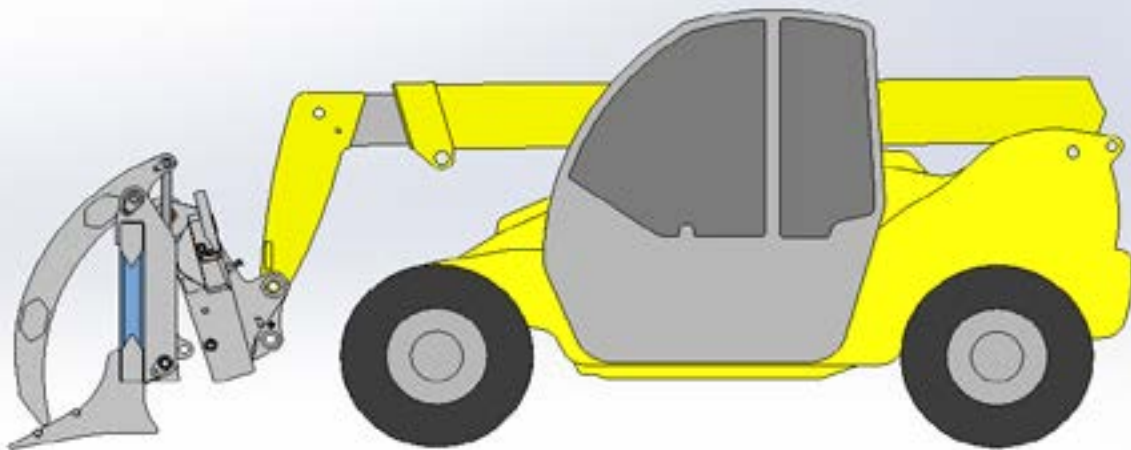

STEP 4

Lower loader arms until top pick-up bar becomes disengaged from quick coupler hooks

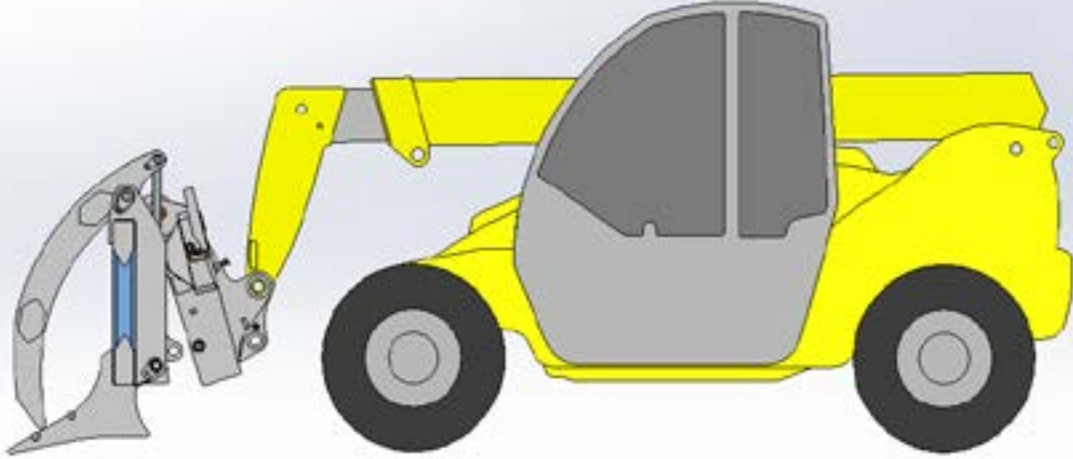
**STEP 5**

Reverse away from Short Tine Scrub Grapple.

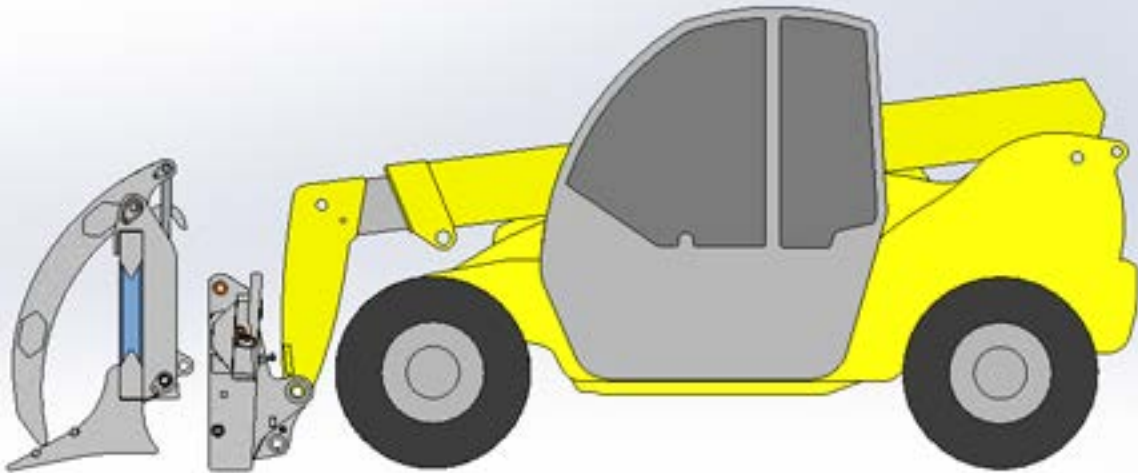

HYDRAULIC SUPPLY INSTALLATION INSTRUCTIONS

1. Each Short Tine Scrub Grapple comes with provisions to connect the hydraulic supply.
2. Connect hoses from Short Tine Scrub Grapple to the machine. Ensure all hoses are tight and routed correctly to ensure hoses are not damaged while the implement is in use.



Product Registration

Date of Delivery:	
Name:	
Company:	
Street Address:	
Phone Number:	
E-mail Address:	
Model Number:	
Serial Number:	
Sales Order Number:	

I confirm that the operator has read and understands the Operating Instruction and Warranty Terms and acknowledges this by signing the below.

X

DATE:/...../.....



Please email a completed copy to warranty@kerfab.com within 10 days of receipt of the Short Tine Scrub Grapple.

KERFAB WARRANTY STATEMENT

At Kerfab Industries, we take pride in delivering materials handling products that meet and exceed the highest industry standards. Our commitment to quality ensures that our products are engineered to conform to the stringent Australian Standards, providing customers with robust and reliable solutions for their needs. We stand behind the quality of our products and offer the following warranty provisions:

Warranty Terms:

- (1)** Kerfab warrants that our products shall be free from defects in material or workmanship for a period of **24 months** from the date of delivery to the purchasing customer.
- (2)** At our sole discretion, Kerfab may choose to replace or repair the product or any defective part thereof.
- (3)** This warranty is exclusively for the benefit of the named original customer and cannot be transferred or assigned.
- (4)** The warranty applies only to Kerfab products fitted or installed by Kerfab or our approved installers.
- (5)** Travel costs associated with assessing or repairing a Kerfab product covered under this manufacturer's warranty are not included.

Customer Responsibilities:

This warranty is subject to and conditional upon the strict compliance of our customers with the following responsibilities:

- (1)** Customers must notify Kerfab as soon as possible of any claims or circumstances that may give rise to a claim.
- (2)** Customers must provide Kerfab with details of the claim, along with any other information reasonably required to evaluate the claim.
- (3)** The product should not be used once a defect is apparent.
- (4)** It will be the customers financial responsibility to cover freight to return the attachment / component for assessment. Any claims that are then deemed warrantable the freight cost will be reimbursed.
- (5)** Repairs or attempts to repair the defect by any other party without prior written approval from Kerfab are not allowed.

Warranty Exclusions:

Not everything is covered by this warranty. The following exclusions apply:

- (1)** Mechanical failures due to a failure to comply with the service requirements as specified.
- (2)** Repairs required because of continued operation of the item once a defect or fault has occurred, including the loss of lubricants and coolant that results in consequential damage to associated components or systems.

(3) Consequential damage as a result of hydraulic fluid contamination to other components or system related ancillaries. This is not specific to but includes pumps, hoses, fittings, cylinders, valves and reservoirs.

(4) Damage resulting from impacts or road traffic accidents.

(5) Kerfab Industries are not responsible for any impact to business or financial loss due to the failure of an attachment or component.

This includes but it not limited to:

- personal liability
- work contract or agreement
- revenue or profit
- production
- increase to a business overhead cost

(6) Claims where damage to a covered component was caused by a non-covered component.

(7) Mechanical failures caused by misuse, neglect, abuse, negligence, lack of normal maintenance, improper servicing, or incorrect operation of the item as per the operations guide as determined by the Kerfab warranty administrator / supervisor.

(8) Ground Engaging Tools – Cutting Edge, Bucket Wraps, Teeth, Adapters

(9) Chassis and Wearing Components – Bruising on Coupler Chassis, Pins, Bush & Bearing wear, Spring Tensions or components considered a “wear and tear” item.

(10) Claims attributable to failure to follow the manufacturer’s operating guidelines or exceeding the manufacturer’s operating limitations.

(11) Claims where Kerfab has not been contacted before the commencement of repairs or repairs initiated without a Kerfab-issued work authorization number.

(12) Claims where the repair has not been performed by Kerfab, unless specifically authorised by Kerfab before the claim.

(13) Mechanical failures arising from unauthorised repairs.

(14) Mechanical failures attributed to modifications unless the modification has been endorsed by Kerfab in writing. Modified components must be disclosed in your warranty application and are expressly excluded from coverage.

(15) Failures caused by corrosion, electrolysis, fertiliser or rust.

(16) Tapping’s, threads, and fixing/fastening devices.

(17) Mechanical failures caused by a fault existing before the commencement of coverage.

(18) Use of the product for a purpose not specifically designed or intended by the manufacturer.

At Kerfab Industries, we are dedicated to providing you, with high-quality load handling products and support. This warranty statement reflects our commitment to ensuring your satisfaction and peace of mind from our dedicated aftersales team.